



LG2215, LG2215B

LED LINEAR LIGHT PROFILE SPECIFICATIONS



Job Information	
Project Name	
Type	
Location	
Quantity	
Date	



- SILVER 
- BLACK 
- WHITE 

DESCRIPTION

Designed for variety of installations, these aluminum profiles are ideal for millwork, walls, and ceilings. It delivers sleek linear lighting in any settings.

Available in 10' lengths, this profile allows for versatile design expression in both residential and commercial spaces.

PERFORMANCE

MODEL NAME	LG2215, LG2215B
MOUNTING OPTIONS	SURFACE/RECESSED/PENDANT
LIGHT SOURCE TYPE	COB/SMD LED STRIP
LIGHT SOURCE WIDTH	18 mm MAX
PC COVER	OPAL/TRANSPARENT/DIFFUSER
FINISH	ANODIZED PAINTING
COLOR	BLACK/WHITE/SILVER
IP	20
APPLICATIONS	INTERIOR, RESIDENTIAL, COMMERCIAL

DIMENSIONS

LG2215

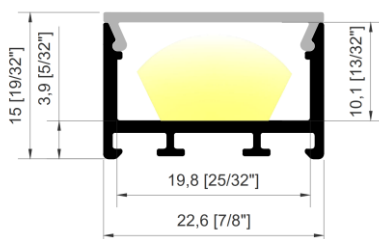

LG2215B

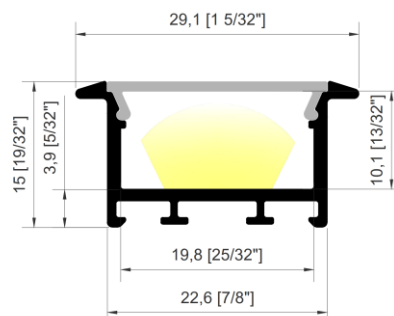

LG2215, LG2215B

LED LINEAR LIGHT PROFILE SPECIFICATIONS

PRODUCT ORDERING GUIDE

EXAMPLE: LG2215B-3M-SL-O

SERIES	LENGTH	REFLECTOR FINISH	PC COVER
LG2215	1M	WH: WHITE	O: OPAL
LG2215B	2M	SL: SILVER	C: CLEAR
	3M	BK: BLACK	D: DIFFUSER



1. put the magnet into the slot 2. Absorbing the metal 3. Installation completed

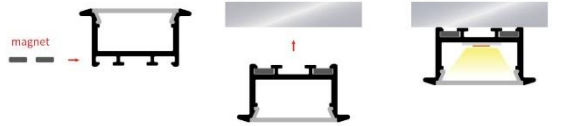

1. Using screw to fix the clip 2. Pressure 3. Installation completed

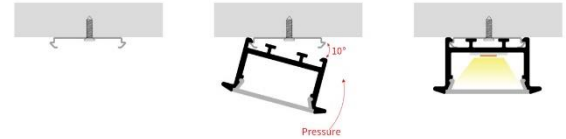

1. Fixing the hanging part in the ceiling 2. Fixing the screw in the aluminum 3. Installation completed

