

INSTALLATION GUIDE

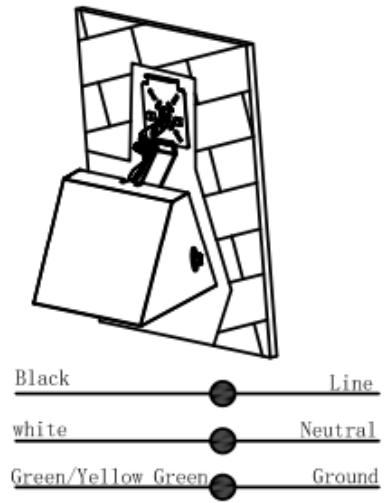

INSTALLATION GUIDE

CCT & Wattage Adjustable and Microwave installation instructions

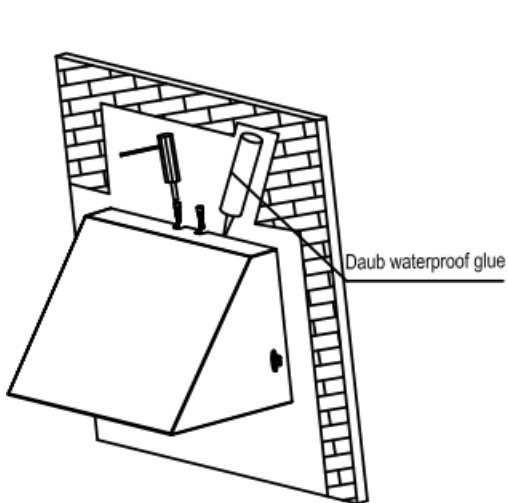
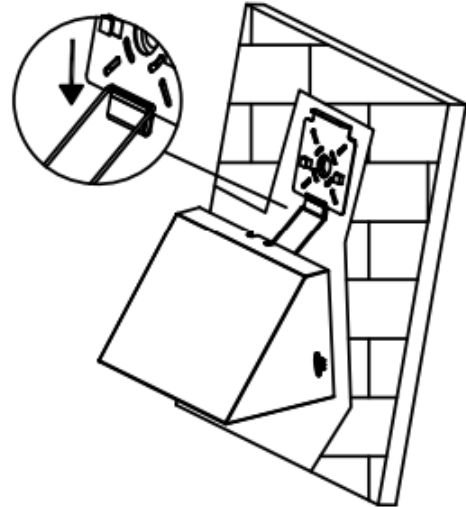
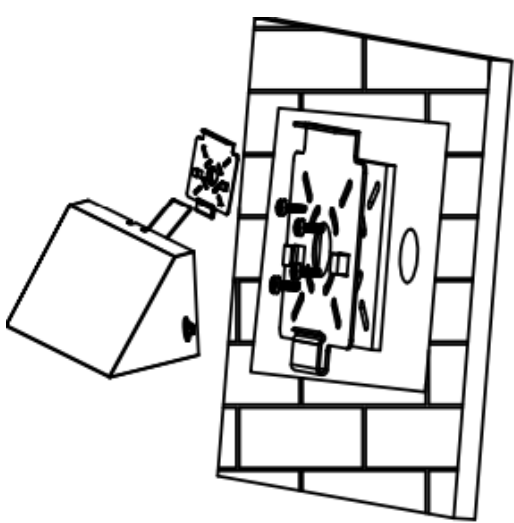
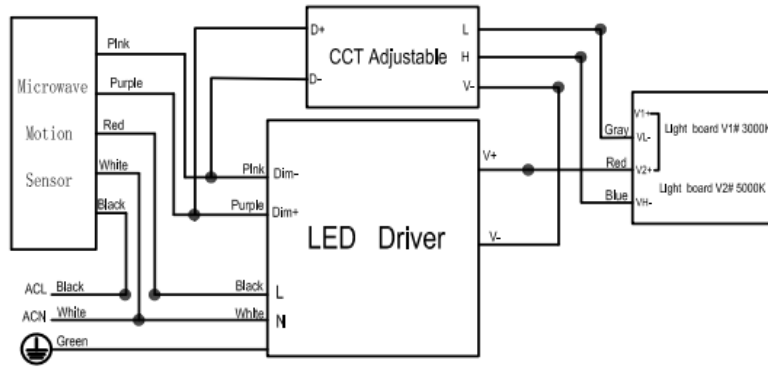
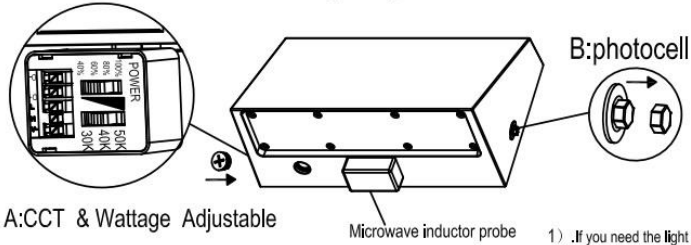

A: CCT & Wattage Adjustable

Microwave inductor probe

1) .If you need the light photocell function, remove the light control cover B.

2) .Like picture A, Unscrew the plug, adjust wattage and cct as desired, and tighten the plug .

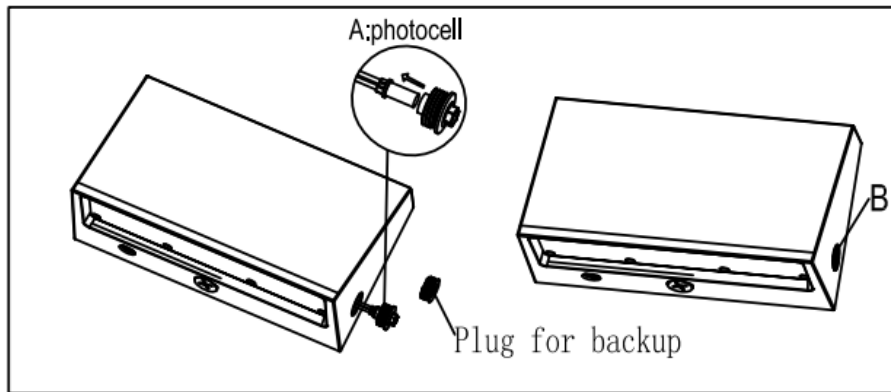

A: photocell

Plug for backup