

PM-BL09

LED BOLLARD LIGHT



DESCRIPTION

The BL09 is a slim and creative bollard light which with its unique aesthetic design can help light up your project space. Intelligent controls such as PIR sensors, light control sensors save on energy bills. IP66 and IK08 rated, 1/2 zoned independent control, also features UV resistant polycarbonate optics for a variety of outdoor applications.

OVERVIEW

- 1/2 zone area can be controlled independently
- 110 LPW @4000K 80Ra
- PIR sensor, photocell sensor optional
- Standard power and color temperature adjustable
- IP66 and IK08
- Excellent corrosion resistance, enduring salt spray testing for over 720 hours
- Lens polarized optical design, wider lighting range
- Custom height of 32" to 42" available, head assembly and pole assembly can be shipped separately

Job Information

Project Name	
Type	
Location	
Quantity	
Date	

PERFORMANCE

Model No.	MP-BL09
Power Consumption(±10%)	15/20/25W Selectable
Input Voltage	120-347VAC, 50/60 Hz
Luminous Flux (±10%)	25W: 2333-2498 lm 15W: 1505-1595 lm
Efficacy(4000K Ra80)	110lm/W
Correlated Color Temperature	3000K, 4000K, 5000K Selectable
Color Rendering Index	80
Dimming	0-10V
Control	PIR Sensor/Dimming/Photocell
Power Factor	>0.9
Flicker Factor	<5%
THD	<20% @120-347V
Surge Protection	4kV L-N, 4kV L/N-E
Light Source	LED 2835
Material	Aluminum body, PC lens
Finish	Powder Coating
Fixture Color	Black
Luminaire Net Weight	5.07kg (11.17Lbs) to 5.77kg (12.72Lbs) based on height
Product Dimension	Ø7.28"xØ5.24"xH32"-42"
IP Rating	IP66
IK Rating	IK08
Working Temperature	-40°C to +50°C (-40F to +122F)
Lifespan of LED @Ta=25°C	50000 Hours (Based on LM79 Report)
Warranty	5 Years
Application	Outdoor application such as pathways, parks, etc

PM-BL09

LED BOLLARD LIGHT

PRODUCT ORDERING GUIDE

EXAMPLE: PM-BL09-42-3CCT-80-V-B-B-PC

SERIES	HEIGHT	CCT	CRI	DIMMING	FRAME FINISH	MOUNTING OPTIONS	CONTROL OPTIONS
PM-BL09	32: 32 INCHES 42: 42 INCHES XX: 32 - 42 INCHES	3CCT	80	V: 0-10V	B: BLACK	A: ANCHOR BOLT B: BACKFILLED ANCHOR	PC: PHOTOCELL PR: PIR SENSOR

Factory set:
100% brightness, 4000K

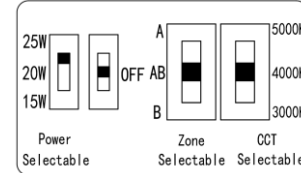
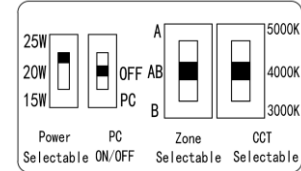
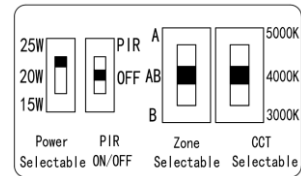
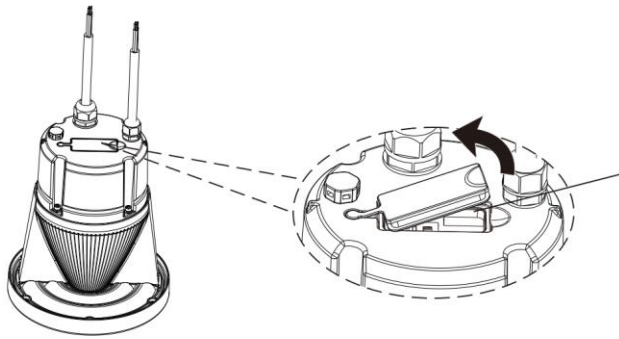

FEATURES

Optics

Full Zone (170°) and half zone (112°) photometric options are available

Electrical

Voltage: 120-347 V AC, 50 / 60 Hz
 Surge Protection: 4KV L-N, 4KV L/N-E
 Flicker Factor: <5%
 THD: <20%
 Power Factor: >0.9

Environment & Certifications

cETL listed for wet locations

Warranty

5 years limited warranty

Finish

The powder-coated finish ensures a uniform appearance, offering long-term durability and superior aesthetics

Housing Material

Die-cast aluminum housing ensures durability and efficiency with C4 anticorrosion protection for harsh environments. Equipped with UV and heat resistance polycarbonate lens.

LED System

CRI With a 80+ color rendering index (CRI), this product delivers adequate illumination.

CCT Selectable 3000K, 4000K, 5000K with excellent color consistency.

Thermal Management The aluminum housing serves as an efficient heat sink to maximize lifespan, maintaining heat sink temperatures between 60-70°C

Control

- Photocell: Lights out 30 seconds after sunrise, lights on 5 seconds after sunset
- RIP Sensor: When no one, the light power is 3W, sensing someone 1 second 100% light, light 30 seconds after no one automatically reduced to the set power

PHOTOMETRIC DIAGRAM

FULL ZONE:

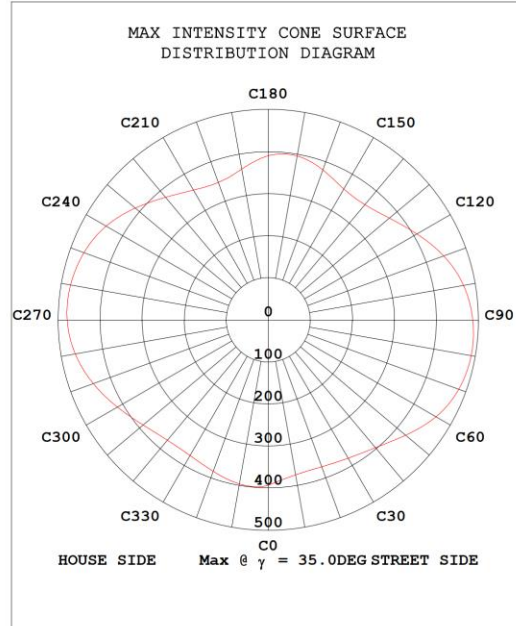
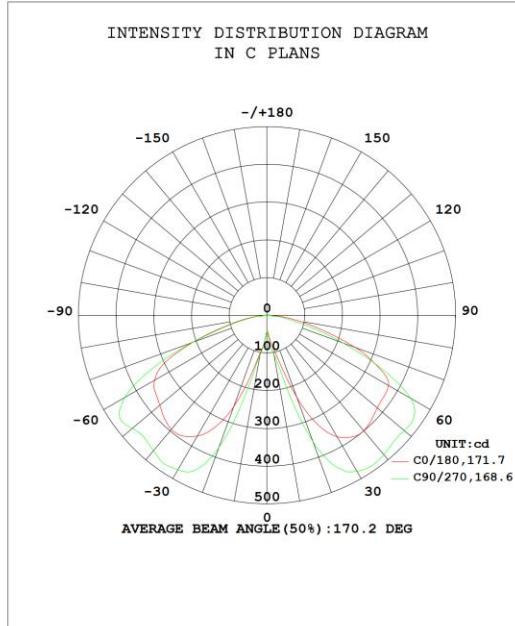

HALF ZONE:

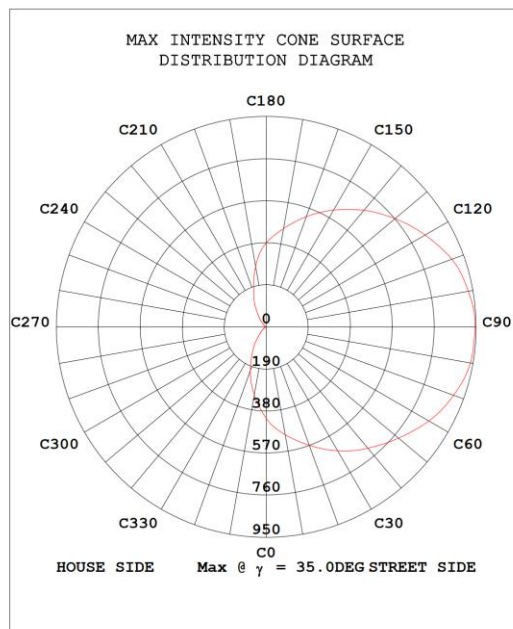
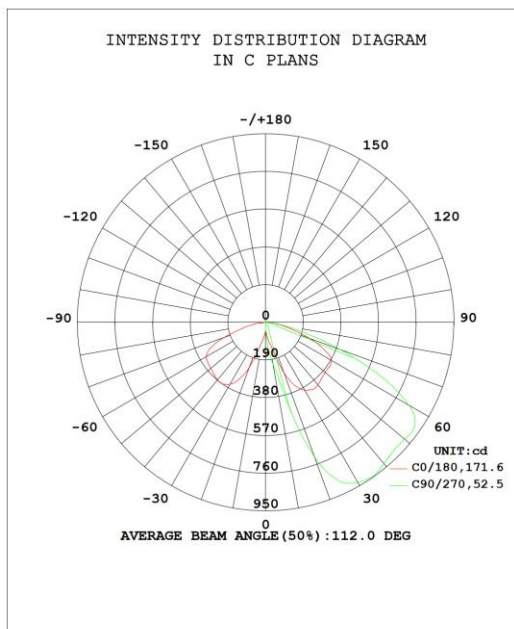

ACCESSORIES



Backfilled Anchor



Anchor Bolt Templates

APPLICATION



Public Spaces



Parks and
Cycle Paths



Squares and
Monuments

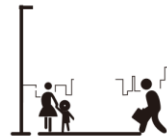

Large Pedestrian Areas



City Streets in
Historic Centers



DIMENSIONS

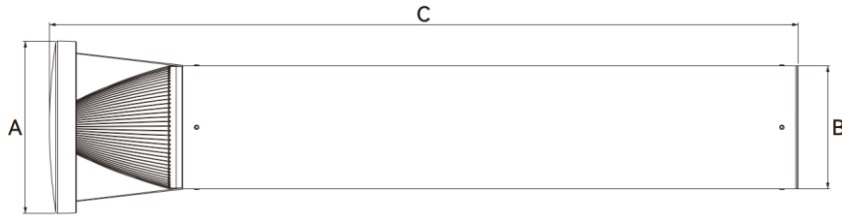

Product Code	Luminaire Dimensions AxBxC (mm/inch)
PM-BL09, 32"	Ø185xØ133x813 (Ø7.28"xØ5.24"x32")
PM-BL09, Custom Height (32" to 42")	Ø185xØ133x813-914 (Ø7.28"xØ5.24"x32"-42")

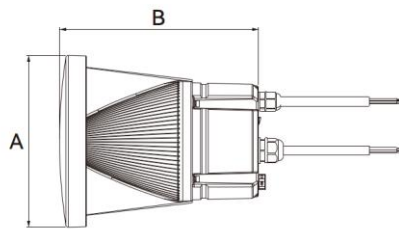

Product Code	Luminaire Dimensions AxBxC (mm/inch)
PM-BL09, 3CCT	Ø185x215.5 (Ø7.28"x8.48")
PM-BL09, 3CCT-PIR	Ø185x215.5 (Ø7.28"x8.48")
PM-BL09, 3CCT, PC	Ø185x215.5 (Ø7.28"x8.48")



Backfilled Anchor

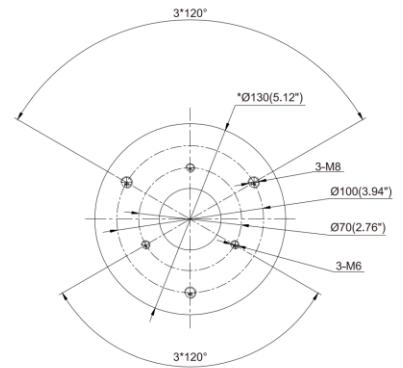
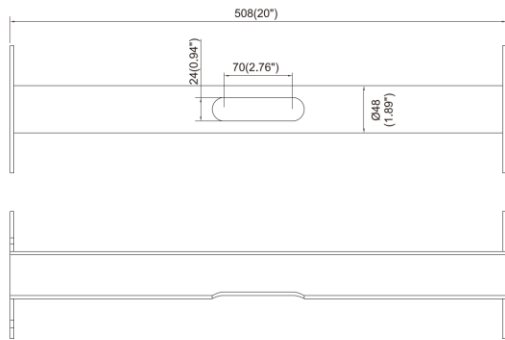

BACKFILLED ANCHOR INSTALLATION

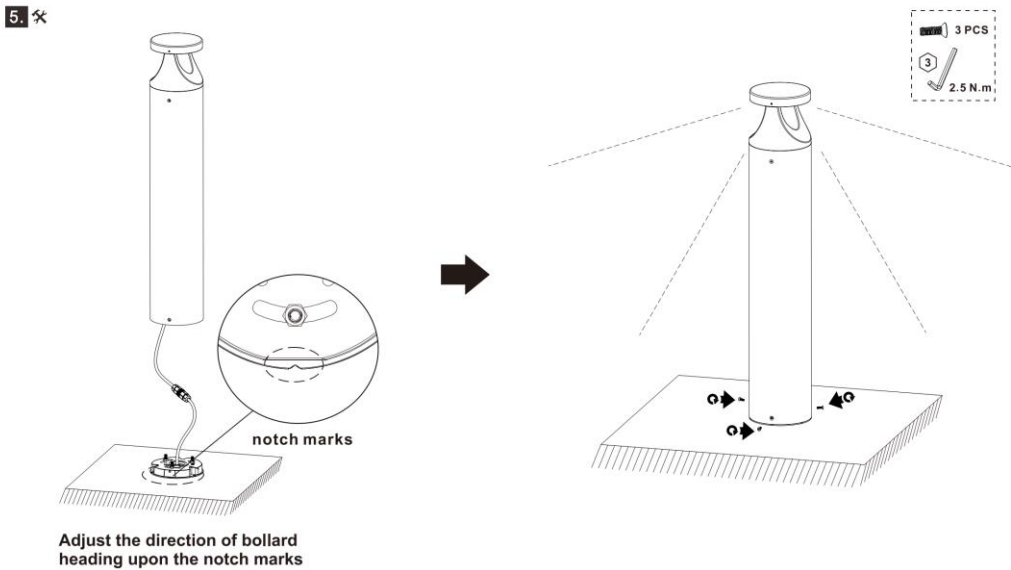
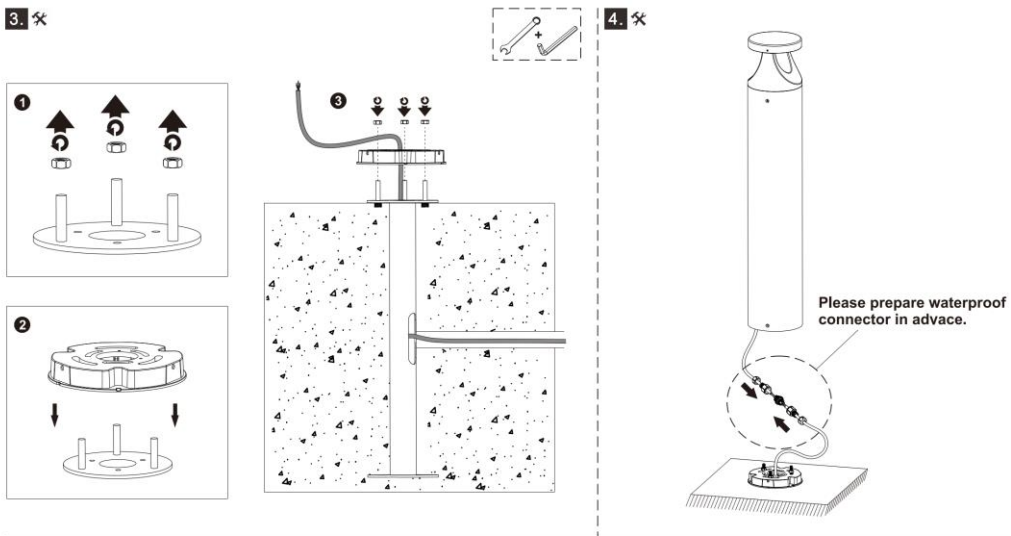
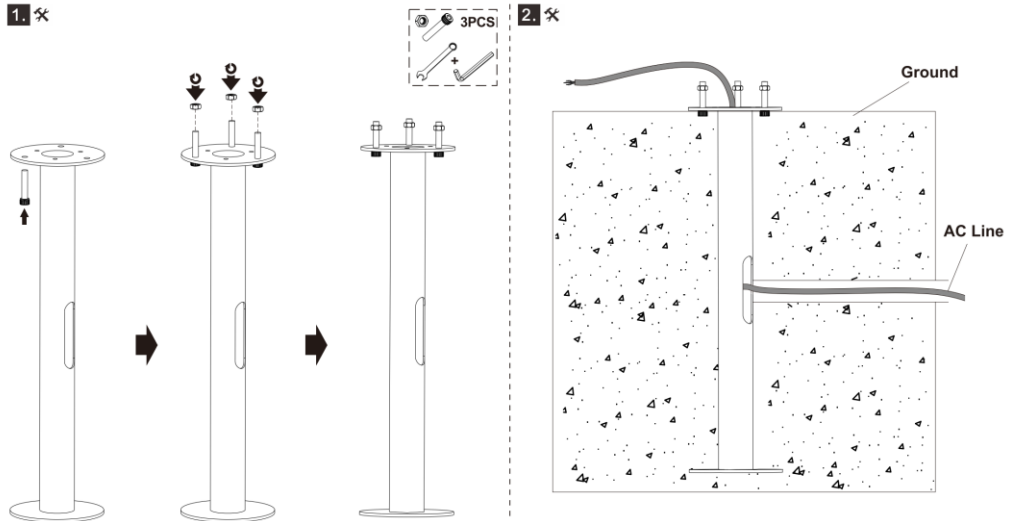

ANCHOR BOLT INSTALLATION

Anchor bolt templates are not included if backfilled anchors are purchased.

