

NEW CONSTRUCTION INSTALLATION MANUAL

1. Make sure the POWER IS TURNED OFF, and secure the metal driver j-box on the bracket.

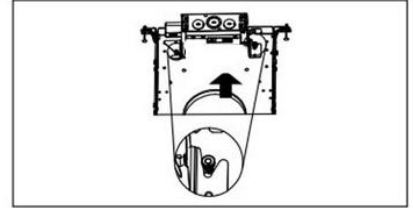

2. Using a hammer, secure the bar hangers to the wood joist with the nail. Secure at all four locations and adjust the position.

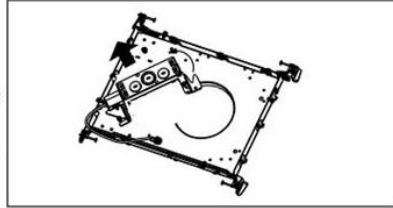
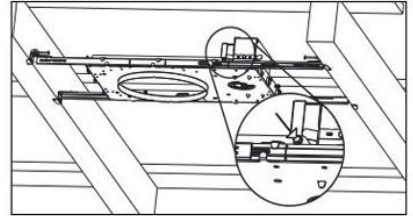
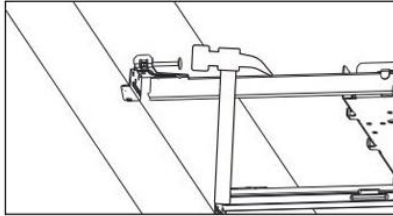

3. Insert the source cable directly into the junction box. Secure it to the ceiling T-Grid using the vertical slots. Lock and secure the frame with screws.

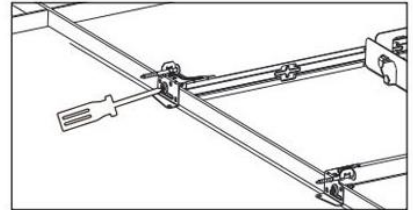
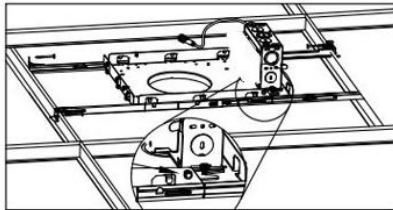

4. If a new hole is needed for the drywall, cut along the edge. Reach and ensure the driver cable is accessible from the ceiling hole.

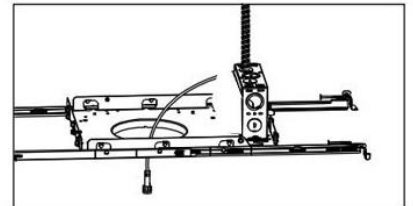
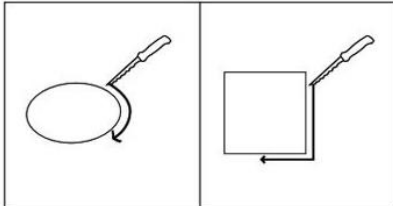

5. Connect the power cord from the driver to the fixture, then insert the lamp into the ceiling.

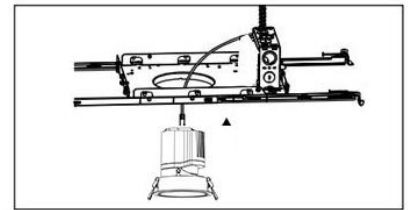
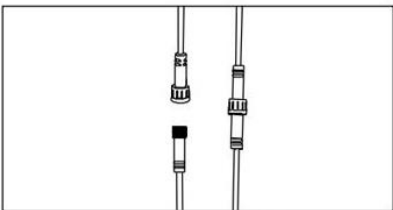

6. Restore power at the source, and the installation is complete.

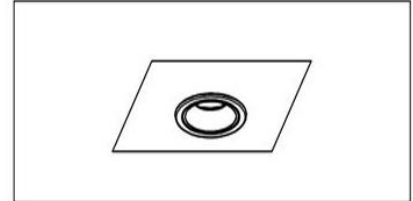
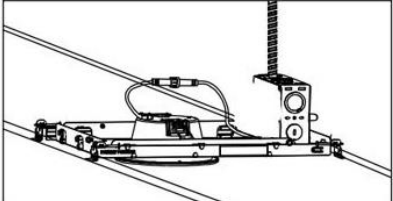

DIRECT INSTALLATION

1. Make sure the POWER IS TURNED OFF. Cut the hole in the ceiling tile, hard lid, or drywall.

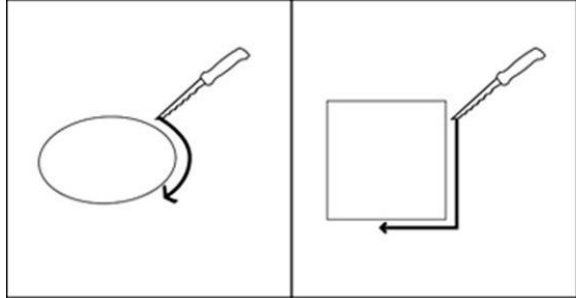

2. Insert the source cable directly into the junction box through one of the knock-outs, and secure it.

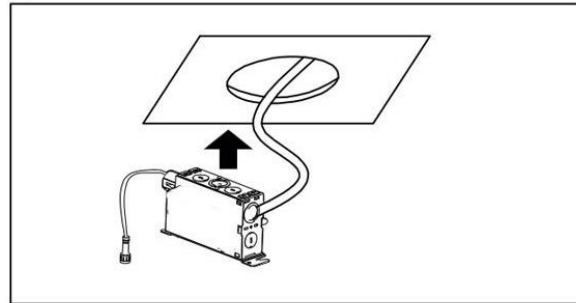

3. Connect the power cord from the driver to the fixture using the cable connector. Secure it by tightening the connector's threaded lock nut.

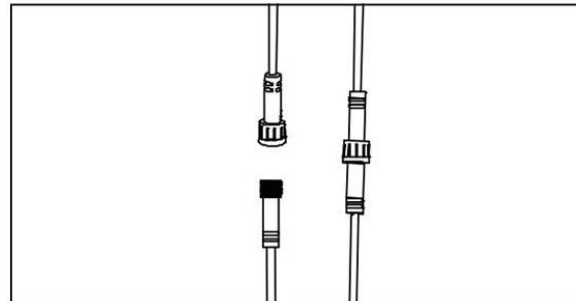

4. Insert the lamp into the ceiling.

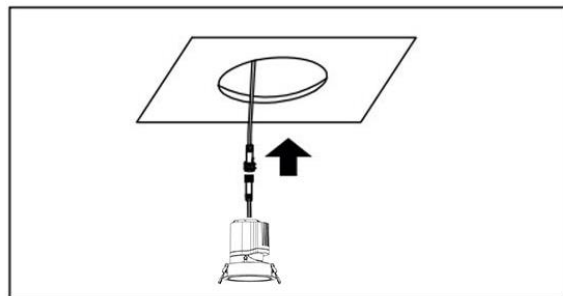

5. Restore power at the source, and the installation is complete.

